



★★★★ FOUR STAR LAMPS VERSION G2 ★★★★★



Add: CN6 Far East Industrial Park, Yuyao, Zhejiang, P.R.China  
 Tel: 0086-574-62760092 62760098 62760099  
 Fax: 0086-574-62760097  
 E-Mail: Jane@fourstarlamps.com Janefsl@163.com  
 Alice@fourstarlamps.com Alice.3@163.com  
 Http: //www.chinalamp.com  
 Http: //www.fourstarlamps.com

 **FOUR STAR LAMPS**  
 余姚市四星灯具有限公司  
 YUYAO FOUR STAR LAMPS CO.,LTD.



# Multi Window

## Patent 专利产品

### Product feature:

- » Die Cast Aluminium Body
- » UV Resistant Powder Coating
- » Glass diffuser
- » Brass or Stainless Steel Fasten Parts

220V~240V / AC 50Hz

MAX 100W

MAX 40W

E27



141001 141201

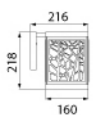

141001

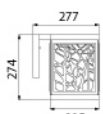

141201



141002



141202

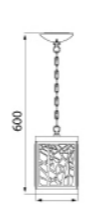

141005

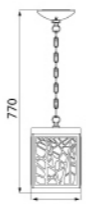

141205

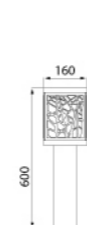

141006



141006



141206



141206



141002 141202



141006 141206



141005 141205



# Multi Window

## Patent 专利产品

### Product feature:

- ※ Die Cast Aluminium Body
- ※ UV Resistant Powder Coating
- ※ Glass diffuser
- ※ Brass or Stainless Steel Fasten Parts

220V~240V / AC 50Hz

MAX 100W

MAX 40W

E27

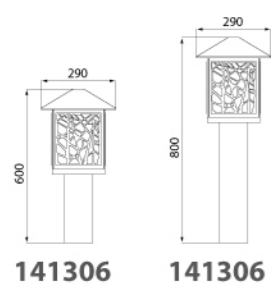
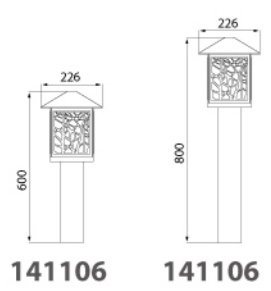
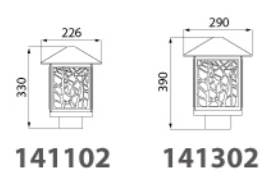
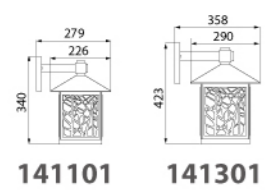

**141101 141301**

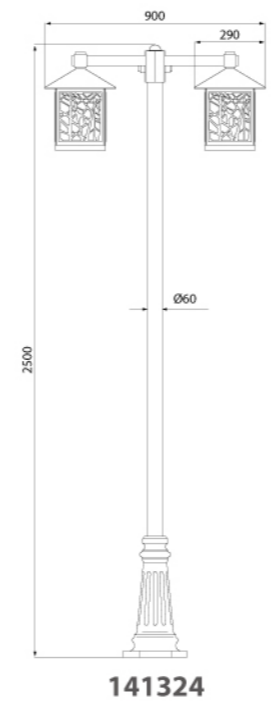
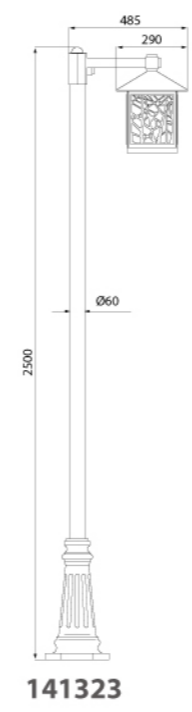
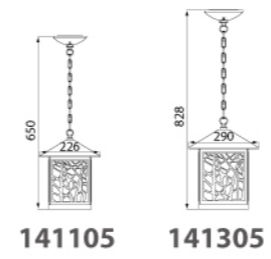

**141102 141302**



**141106 141306**



**141323**



**141105 141305**



**141324**



# Multi Window

## Patent 专利产品

### Product feature:

- » Die Cast Aluminium Body
- » UV Resistant Powder Coating
- » Glass diffuser
- » Brass or Stainless Steel Fasten Parts

220V~240V / AC 50Hz

MAX 100W

MAX 40W

E27

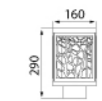

141002A

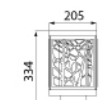

141202A

141002A 141202A

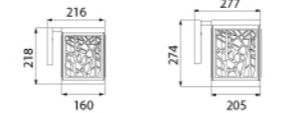

141001A 141201A

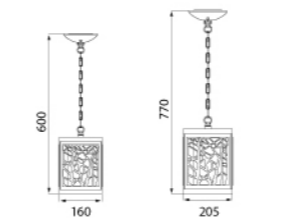

141005A 141205A

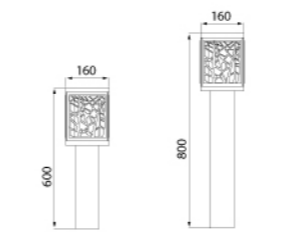

141006A 141206A

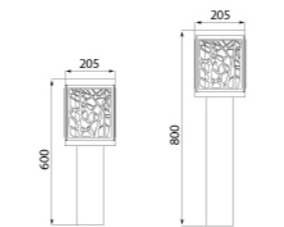

141206A 141206A



141005A 141205A



141001A 141201A

141006A 141206A



**Multi Window**  
**Patent 专利产品**

- Product feature:**
- Die Cast Aluminium Body
  - UV Resistant Powder Coating
  - Glass diffuser
  - Brass or Stainless Steel Fasten Parts

220V~240V / AC 50Hz  
 MAX 100W  
 MAX 40W  
 E27



141101A 141301A



141105A 141305A

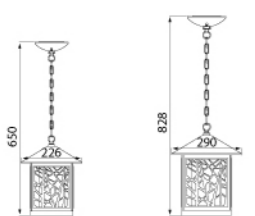

141105A 141305A



141323A

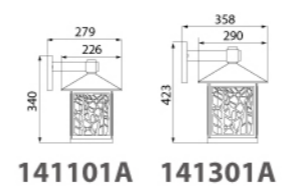

141101A 141301A

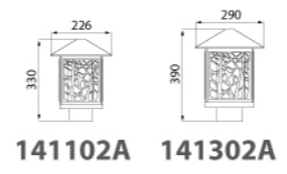

141102A 141302A

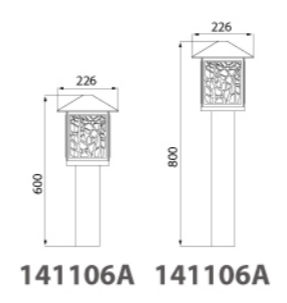

141106A 141106A

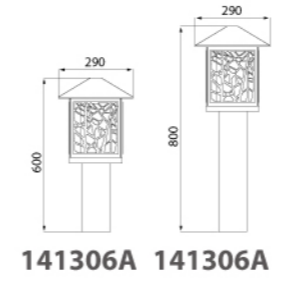

141306A 141306A

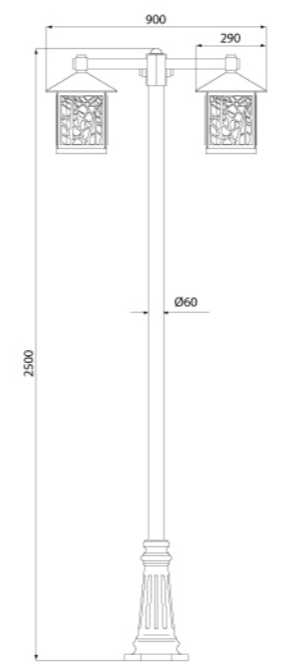

141324A



141102A 141302A



141106A 141306A



141324A



141323A



# Multi Window

## Patent 专利产品

- Product feature:**
- » Die Cast Aluminium Body
  - » UV Resistant Powder Coating
  - » Glass diffuser
  - » Brass or Stainless Steel Fasten Parts

220V~240V / AC 50Hz  
 MAX 100W  
 MAX 40W  
 E27



142002 142202

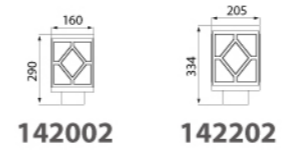

142005 142205

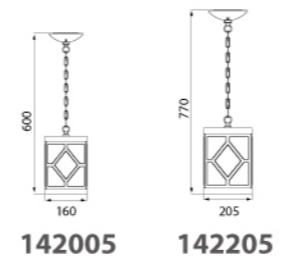

142001 142201

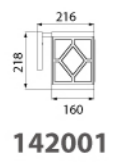

142001

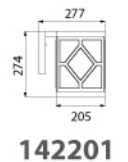

142201

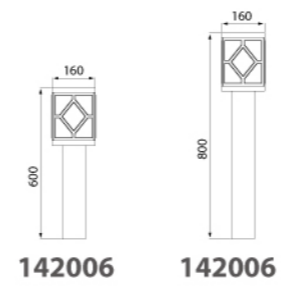

142006 142206

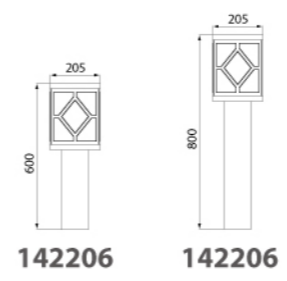

142206 142206



142006 142206



# Multi Window

## Patent 专利产品

### Product feature:

- » Die Cast Aluminium Body
- » UV Resistant Powder Coating
- » Glass diffuser
- » Brass or Stainless Steel Fasten Parts

220V~240V / AC 50Hz

MAX 100W

MAX 40W

E27

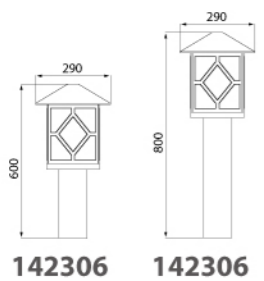
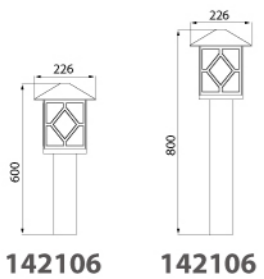
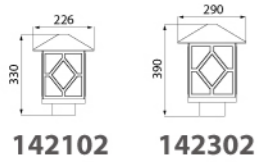
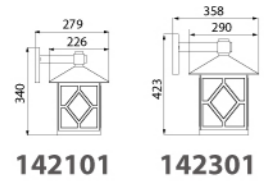

**142101 142301**

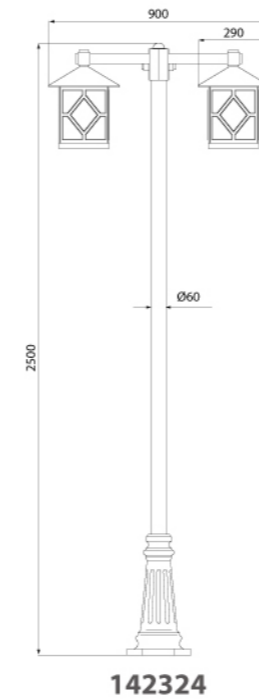
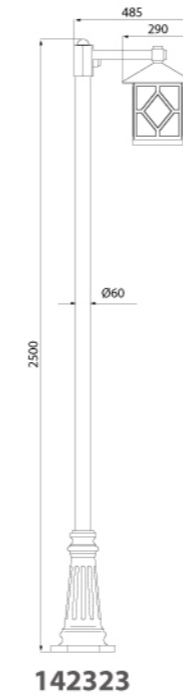
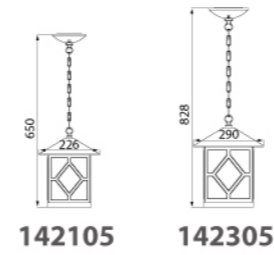

**142105 142305**



**142106 142306**



**142323**



**142102 142302**



**142324**



# Multi Window

## Patent 专利产品

### Product feature:

- » Die Cast Aluminium Body
- » UV Resistant Powder Coating
- » Glass diffuser
- » Brass or Stainless Steel Fasten Parts

220V~240V / AC 50Hz

MAX 100W

MAX 40W

E27

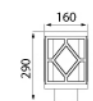

142002A

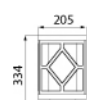

142202A

142002A 142202A

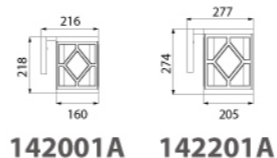

142001A 142201A

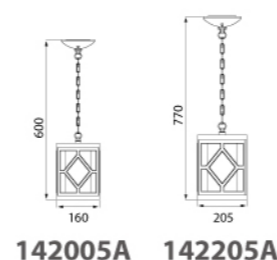

142005A 142205A



142005A 142205A

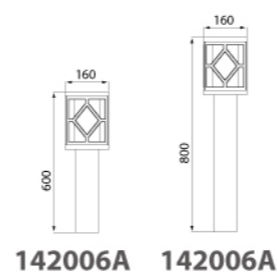

142006A 142206A

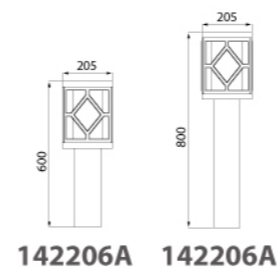

142206A 142206A



142001A 142201A



142006A 142206A



**Multi Window**

**Patent 专利产品**

**Product feature:**

- » Die Cast Aluminium Body
- » UV Resistant Powder Coating
- » Glass diffuser
- » Brass or Stainless Steel Fasten Parts

220V~240V / AC 50Hz

MAX 100W

MAX 40W

E27

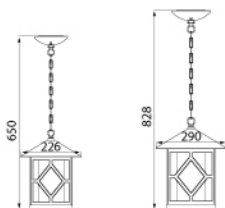

142105A 142305A

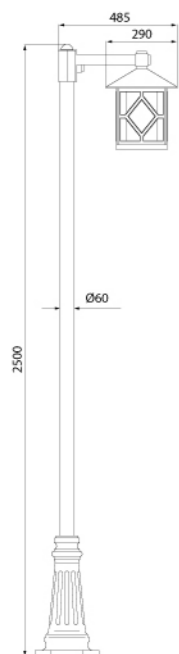

142323A



142101A 142301A



142102A 142302A

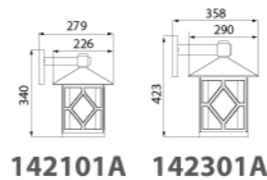

142101A 142301A

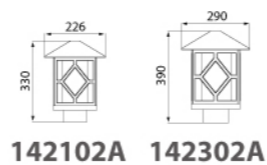

142102A 142302A

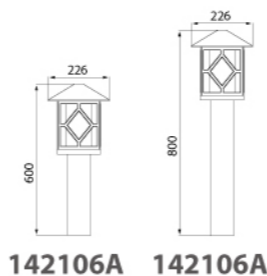

142106A 142306A

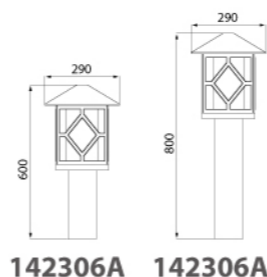

142306A 142306A

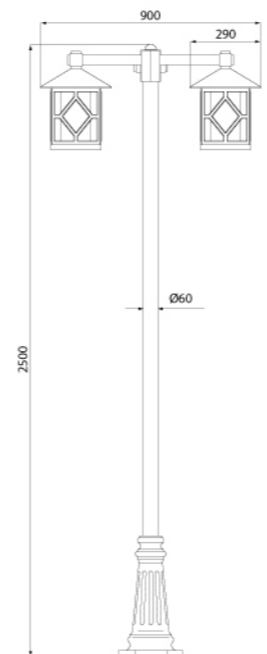

142324A



142105A 142305A



142106A 142306A



142324A



142323A



**Multi Window**  
**Patent 专利产品**

- Product feature:**
- » Die Cast Aluminium Body
  - » UV Resistant Powder Coating
  - » Glass diffuser
  - » Brass or Stainless Steel Fasten Parts

220V~240V / AC 50Hz

MAX 100W

MAX 40W

E27



143002 143202

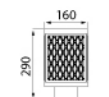

143002

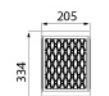

143202

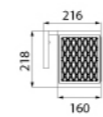

143001

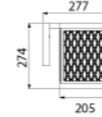

143201

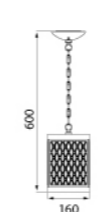

143005

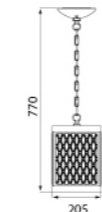

143205

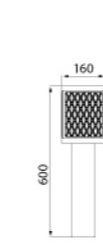

143006

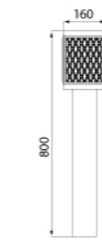

143006

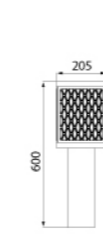

143206

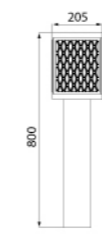

143206



143001 143201



143006 143206



143005 143205



**Multi Window**  
**Patent 专利产品**

- Product feature:**
- ※ Die Cast Aluminium Body
  - ※ UV Resistant Powder Coating
  - ※ Glass diffuser
  - ※ Brass or Stainless Steel Fasten Parts

220V~240V / AC 50Hz  
 MAX 100W  
 MAX 40W  
 E27

CE, RoHS, CCC, IP23 IP33, A, F

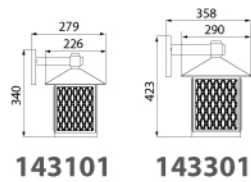

143101 143301

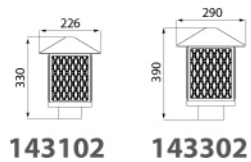

143106 143306

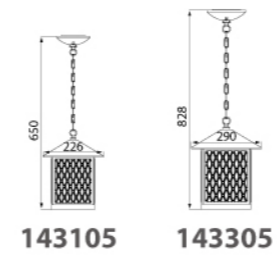
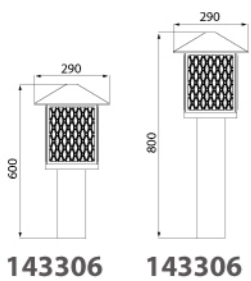
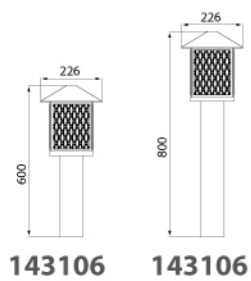

143105 143305



143102 143302

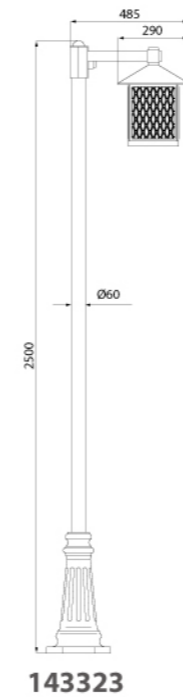

143323



143323

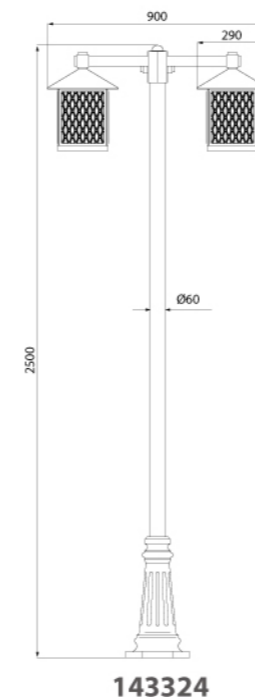

143324



143324



# Multi Window

## Patent 专利产品

### Product feature:

- » Die Cast Aluminium Body
- » UV Resistant Powder Coating
- » Glass diffuser
- » Brass or Stainless Steel Fasten Parts

220V~240V / AC 50Hz

MAX 100W

MAX 40W

E27



143005A 143205A

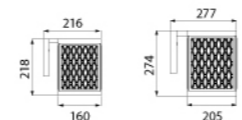

143001A 143201A

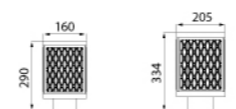

143002A 143202A



143001A 143201A

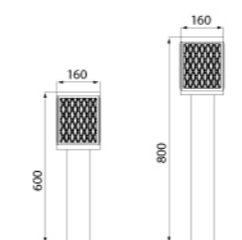

143006A 143206A

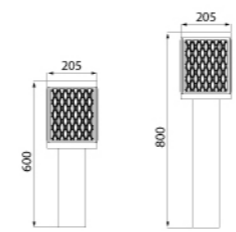

143206A 143206A



143002A 143202A



143006A 143206A

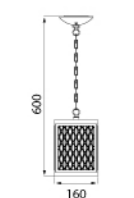

143005A

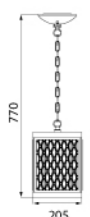

143205A



# Multi Window

## Patent 专利产品

### Product feature:

- » Die Cast Aluminium Body
- » UV Resistant Powder Coating
- » Glass diffuser
- » Brass or Stainless Steel Fasten Parts

220V~240V / AC 50Hz

MAX 100W

MAX 40W

E27

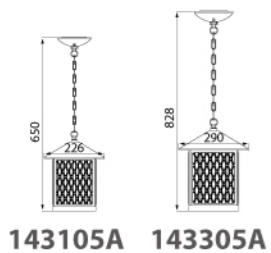

143105A 143305A

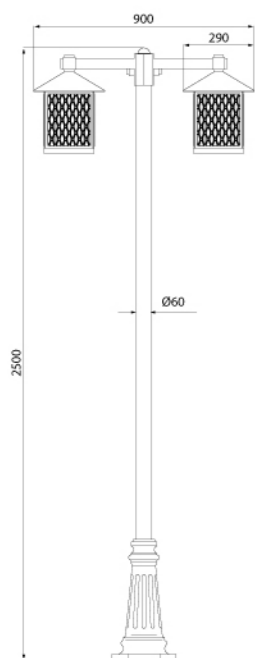

143324A



143324A

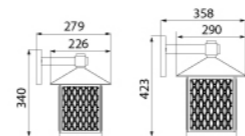

143101A 143301A

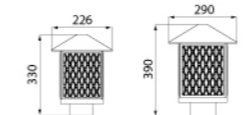

143102A 143302A

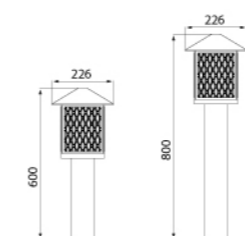

143106A 143106A

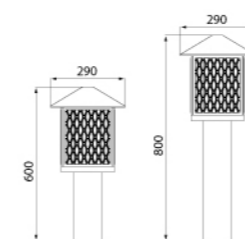

143306A 143306A

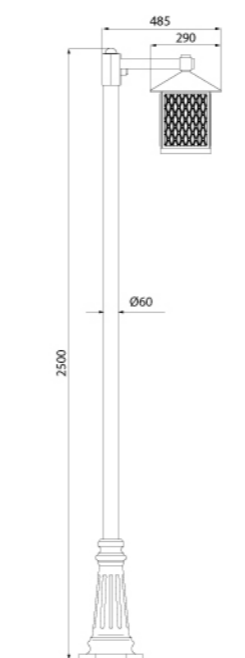

143323A



143101A 143301A



143106A 143306A



141323A



143102A 143302A

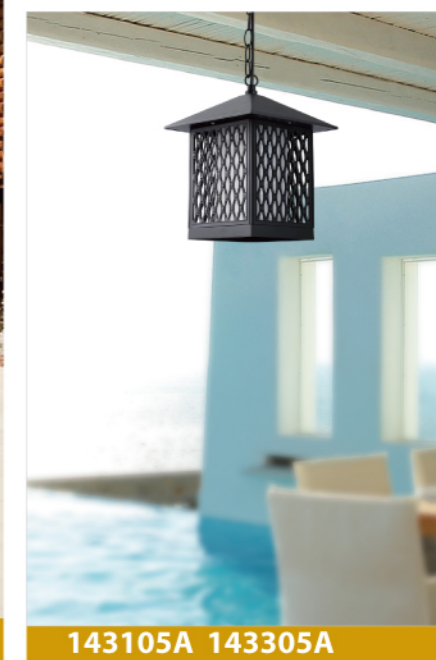

143105A 143305A



# Multi Window

## Patent 专利产品

### Product feature:

- » Die Cast Aluminium Body
- » UV Resistant Powder Coating
- » Glass diffuser
- » Brass or Stainless Steel Fasten Parts

220V~240V / AC 50Hz

MAX 100W

MAX 40W

E27



144001 144201

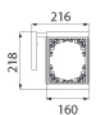

144001

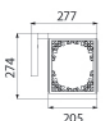

144201



144002



144202

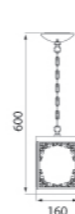

144005



144205

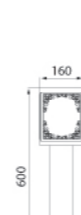

144006



144006



144206



144206



144005 144205



144006 144206



144002 144202



**Multi Window**  
**Patent 专利产品**

- Product feature:**
- ※ Die Cast Aluminium Body
  - ※ UV Resistant Powder Coating
  - ※ Glass diffuser
  - ※ Brass or Stainless Steel Fasten Parts

220V~240V / AC 50Hz

💡 MAX 100W

💡 MAX 40W

E27

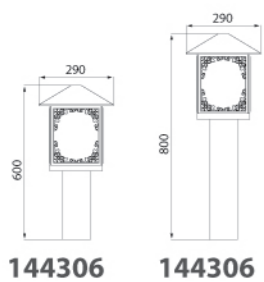
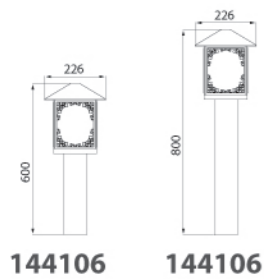
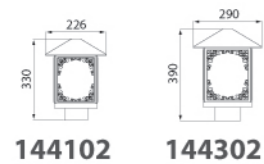
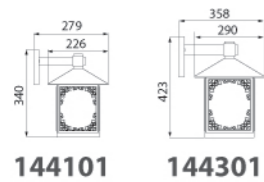

144101 144301

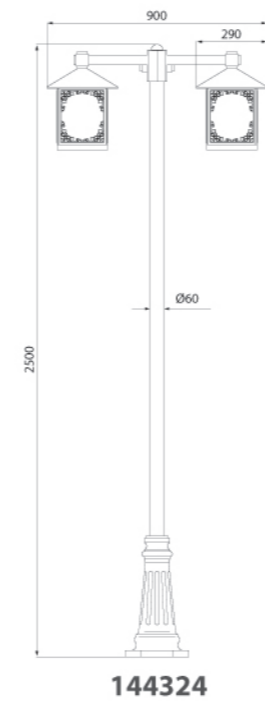
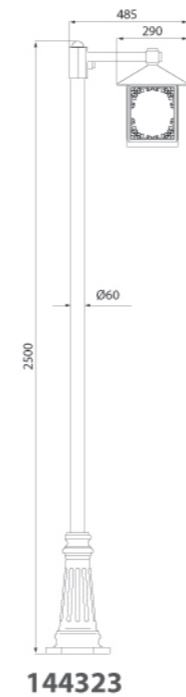
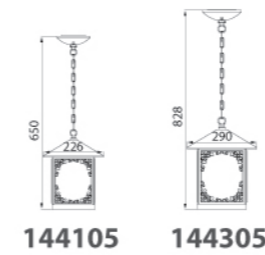

144105 144305



144106 144306



144323



144102 144302



144324





**141121** H6-Ø48

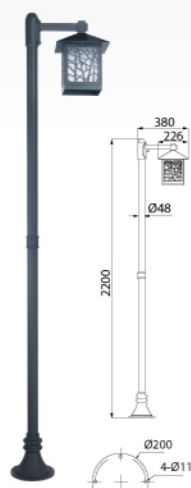

**141122** H6-Ø48

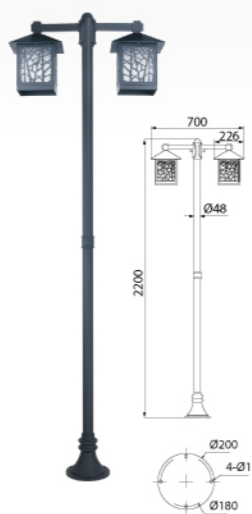

**141123** H6-Ø48

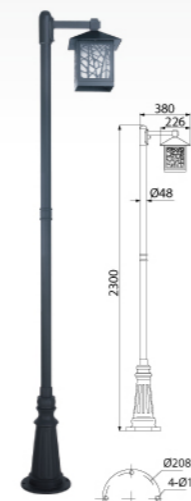

**141124** H11-Ø48

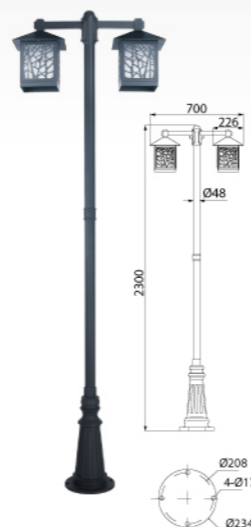

**141125** H11-Ø48

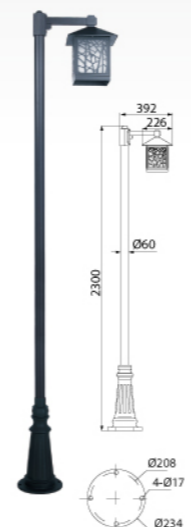

**141126** H11-Ø60



**141121A** H6-Ø48

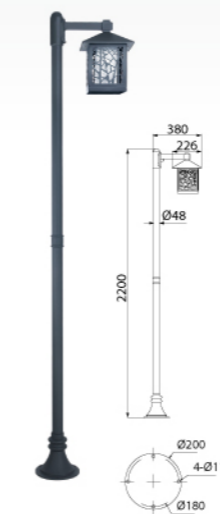

**141122A** H6-Ø48

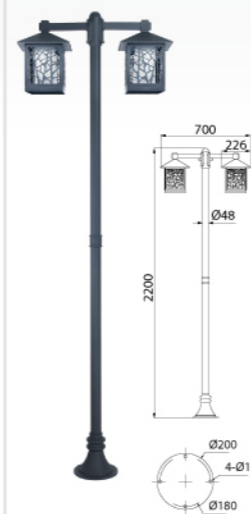

**141123A** H6-Ø48



**141124A** H11-Ø48



**141125A** H11-Ø48

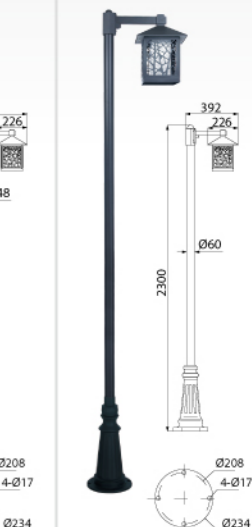

**141126A** H11-Ø60

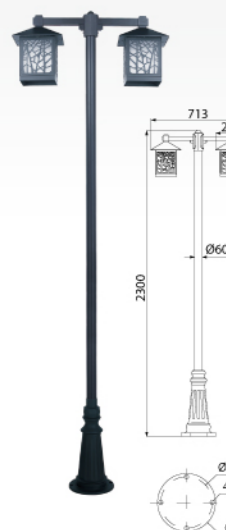

**141127** H11-Ø60

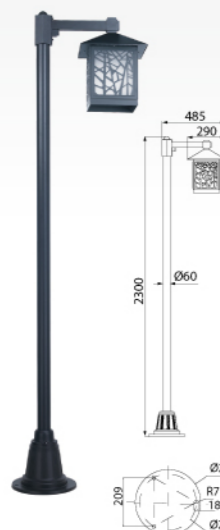

**141321** H9-Ø60

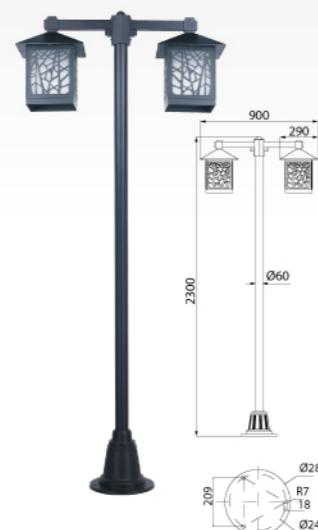

**141322** H9-Ø60

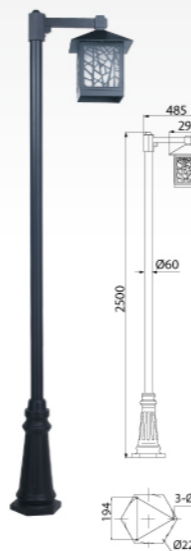

**141323** H2-Ø60



**141324** H2-Ø60

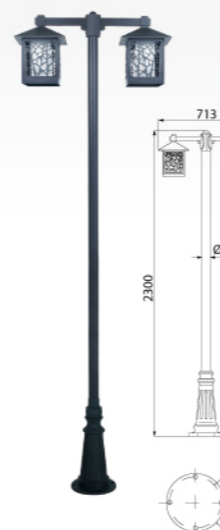

**141127A** H11-Ø60



**141321A** H9-Ø60

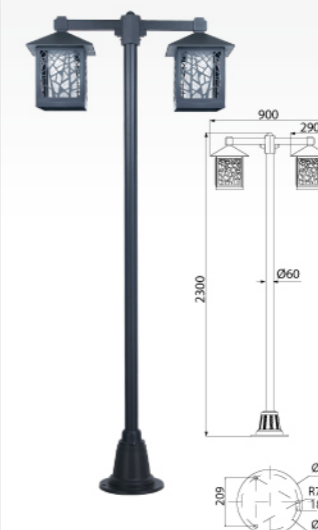

**141322A** H9-Ø60



**141323A** H2-Ø60



**141324A** H2-Ø60



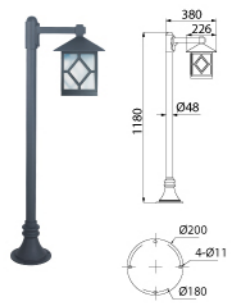

**142121** H6-Ø48

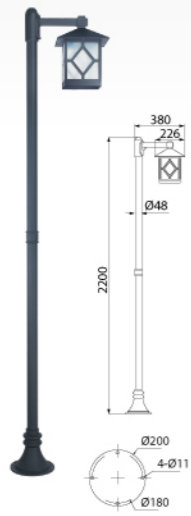

**142122** H6-Ø48

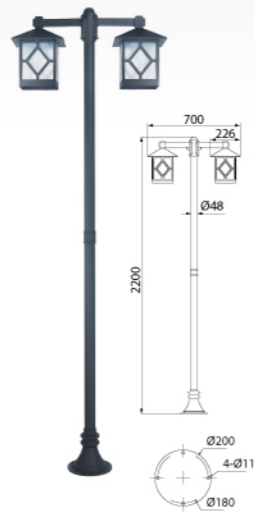

**142123** H6-Ø48



**142124** H11-Ø48

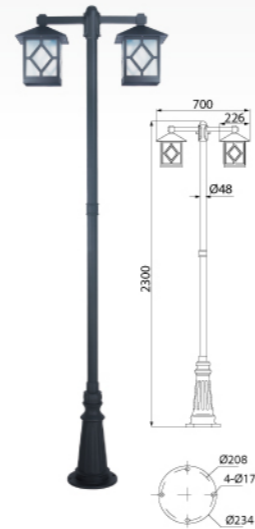

**142125** H11-Ø48

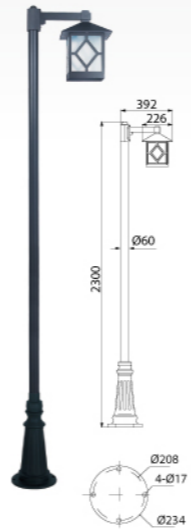

**142126** H11-Ø60



**142121A** H6-Ø48

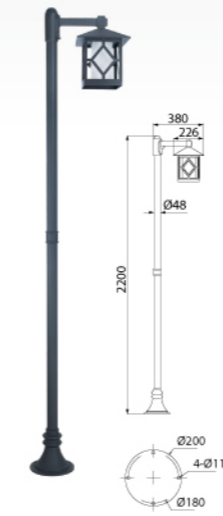

**142122A** H6-Ø48

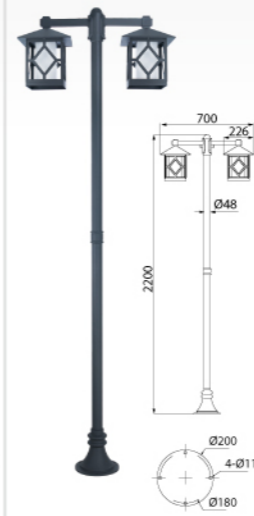

**142123A** H6-Ø48

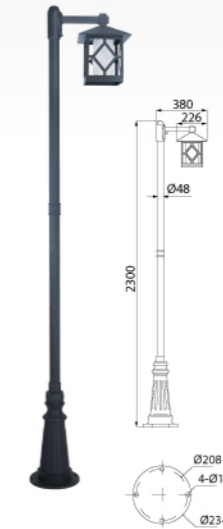

**142124A** H11-Ø48

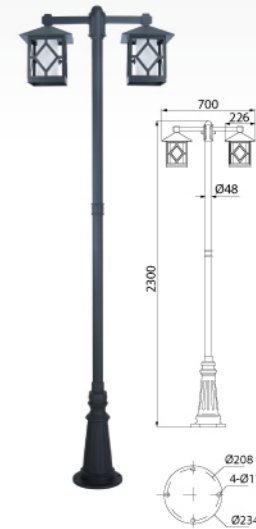

**142125A** H11-Ø48

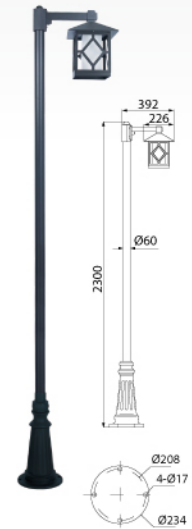

**142126A** H11-Ø60

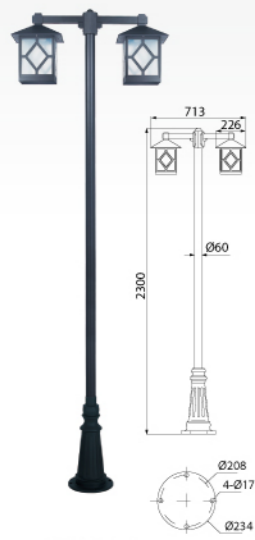

**142127** H11-Ø60

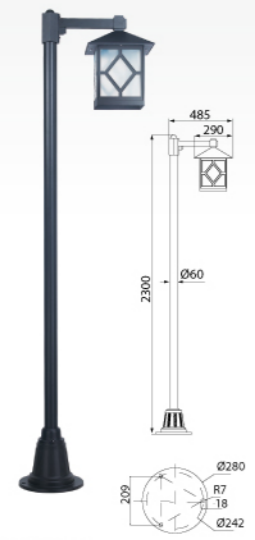

**142321** H9-Ø60

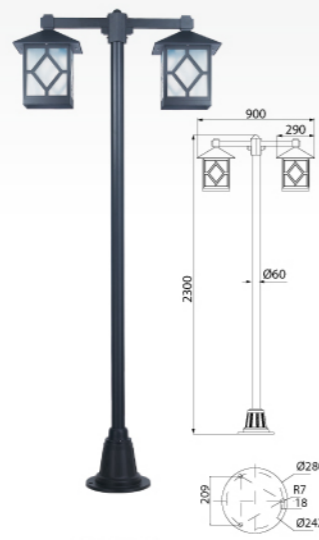

**142322** H9-Ø60

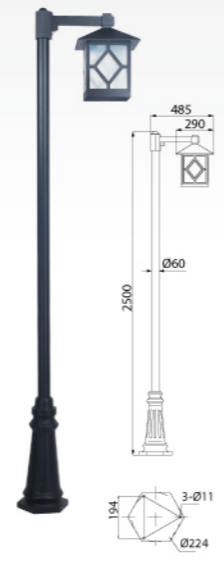

**142323** H2-Ø60



**142324** H2-Ø60

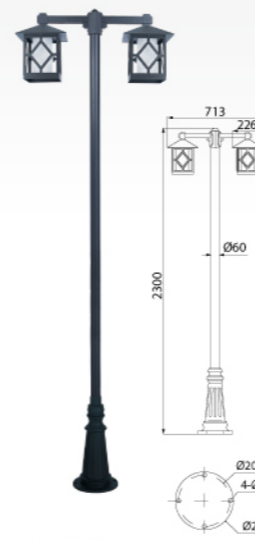

**142127A** H11-Ø60

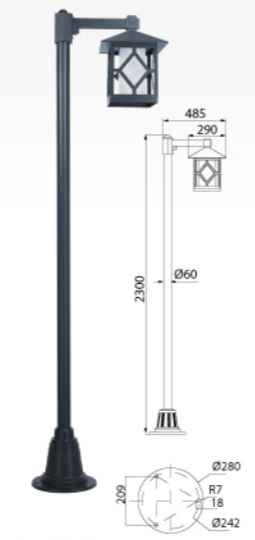

**142321A** H9-Ø60

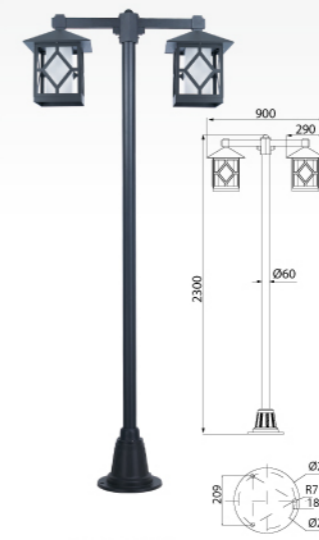

**142322A** H9-Ø60



**142323A** H2-Ø60

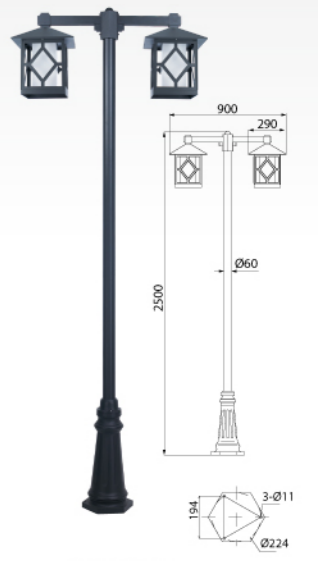

**142324A** H2-Ø60





**143121** H6-Ø48

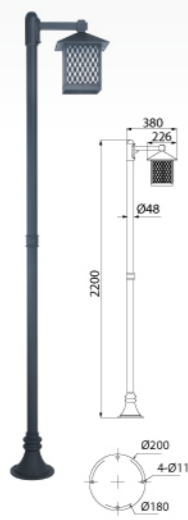

**143122** H6-Ø48

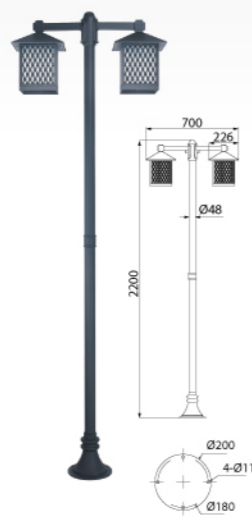

**143123** H6-Ø48

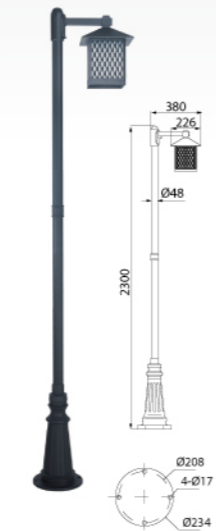

**143124** H11-Ø48

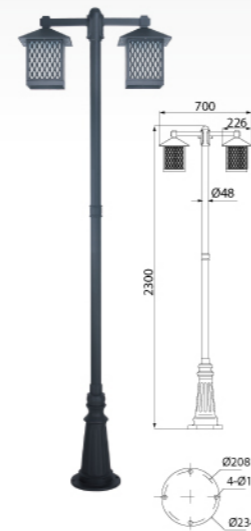

**143125** H11-Ø48

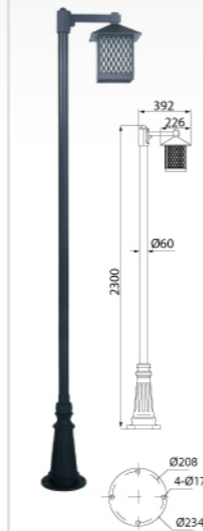

**143126** H11-Ø60



**143121A** H6-Ø48

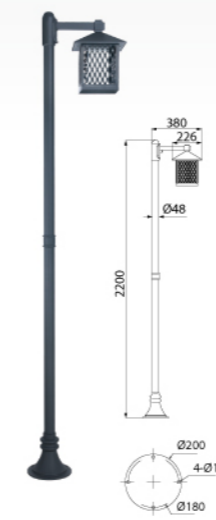

**143122A** H6-Ø48

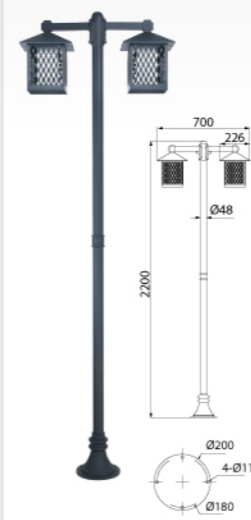

**143123A** H6-Ø48

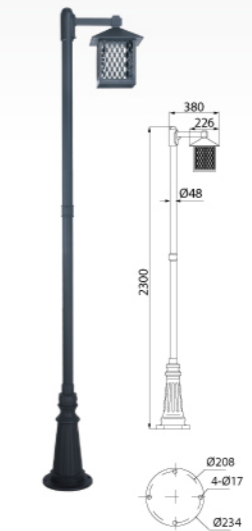

**143124A** H11-Ø48

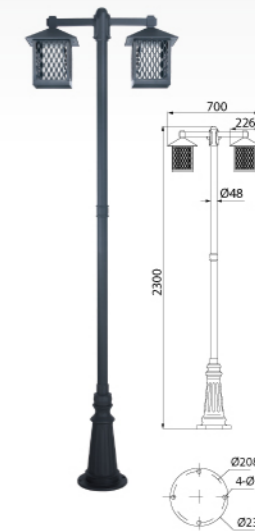

**143125A** H11-Ø48

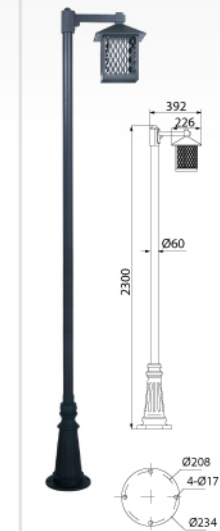

**143126A** H11-Ø60

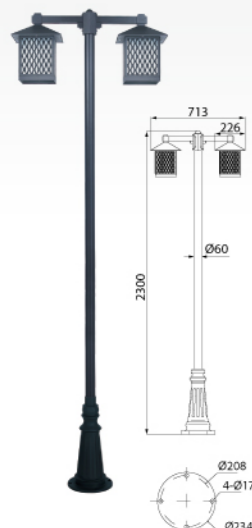

**143127** H11-Ø60

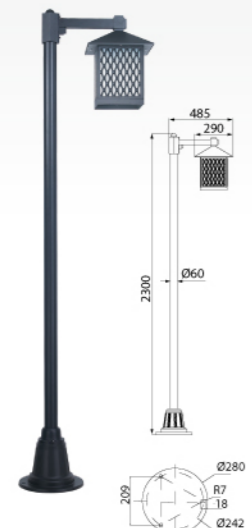

**143321** H9-Ø60

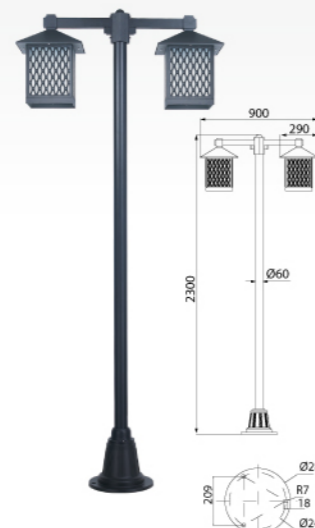

**143322** H9-Ø60

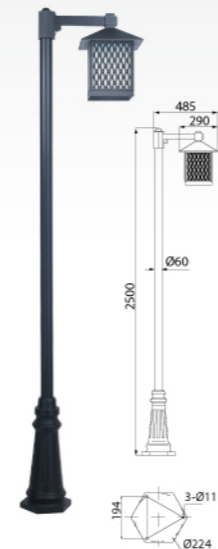

**143323** H2-Ø60



**143324** H2-Ø60

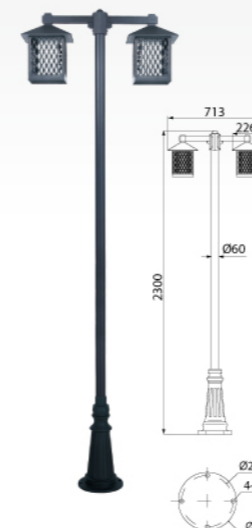

**143127A** H11-Ø60

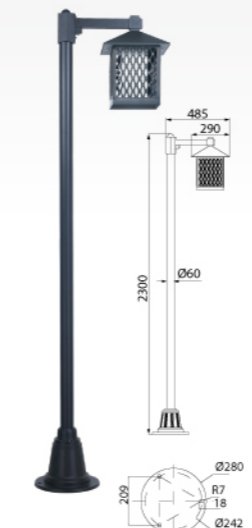

**143321A** H9-Ø60

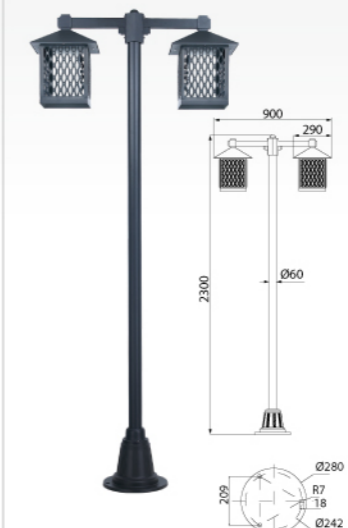

**143322A** H9-Ø60

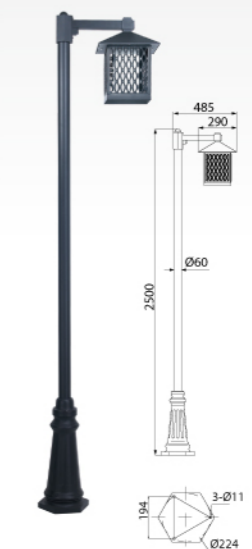

**143323A** H2-Ø60

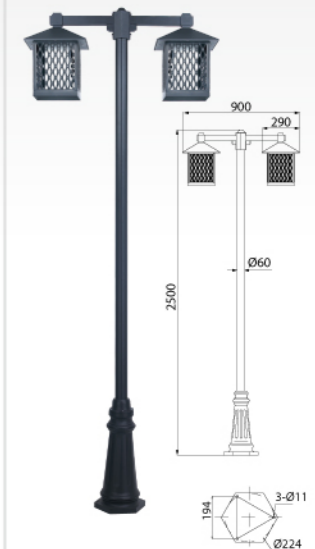

**143324A** H2-Ø60



STANDARD COLOR PLATE



**144121** H6-Ø48    **144122** H6-Ø48    **144123** H6-Ø48    **144124** H11-Ø48    **144125** H11-Ø48    **144126** H11-Ø60



**144127** H11-Ø60    **144321** H9-Ø60    **144322** H9-Ø60    **144323** H2-Ø60    **144324** H2-Ø60



**CP001**    **CP002**    **CP003**    **CP004**



**CP005**    **CP006**    **CP007**    **CP008**



**CP009**    **CP010**    **CP011**    **CP012**